

Bench Scales

Distributor Reference Guide

Important note:
Fairbanks product information located at the **Nexus** platform are updated more frequently and are the best source for current product information.

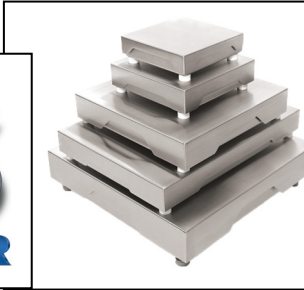

Contents

SilverBack Carbon Steel Bench Scale	3
SilverBack (Gen 2) Carbon Steel Bench Scale Pricing.....	4
SilverBack Bench Scale Kits w/ Resin Alloy FB1200	4
SilverBack Bench Scale Kits w/ Stainless Steel FB1200	7
SilverBack Bench Scale Kits w/ FB2250s & NexWeigh Instruments.....	8
How to build a Stainless Steel Washdown Bench Scale.....	9
1 - Quicksilver Platform	9
2 - Instrument.....	9
2a - Power Source for QuickSilver Intrinsically Safe Instrument.....	9
3 - Pillar Kit or Bracket	9
4 - Accessories to specialize the Bench Scale	9
QuickSilver.....	10
QuickSilver Platform Pricing	11
QuickSilver Pillars	12
Bench Scale Stands.....	12
QuickSilver Instruments	13
QuickSilver Intrinsically Safe Instrument & Power Source.....	15
Ultegra Series Scales.....	16
Ultegra Health & Baggage Scales, Teleweigh & Slimline	16
Parcel Dimensioner Shipping Scale.....	17
Roller Conveyor Scale.....	18

The prices and product information in this catalog are for reference only. Please check the Fairbanks Nexus online catalog system for the most up to date information.



SilverBack Carbon Steel Bench Scale

SilverBack

Carbon Steel Base w/ Stainless Steel Shroud

This new generation of Fairbanks bench scales builds on the popular QuickSilver design to open new opportunities for rugged, competitively priced weighing platforms in non-washdown applications.

Virtually indestructible and highly accurate carbon steel weighing platforms designed for dry applications in manufacturing, agriculture, warehousing and recycling. Configure the SilverBack with your analog instrument of choice to create a bench scale perfectly suited for your weighing application and weighing budget.

The New "Tough" Platform on the Market

- Super heavy-duty construction
- Based on the proven QuickSilver Design
- 150% overload protection
- Made in the USA
- Competitively Priced
- Leveling feet and bubble level come standard
- Compatible with all Fairbanks analog instruments, as well as analog instruments produced by other manufacturers



SilverBack Platforms

- Sizes range from 10" x 10" up to 24" x 24"
- Capacities from 25 lbs. up to 1,000 lbs.
- Construction:
 - Mild Steel Base
 - Stainless Steel Shroud
 - Stainless Steel or Anodized Aluminum Load Cell
- 10", 12", 18", 24" and 30" Pillars available (depending on platform size)
 - Comes in 2 pieces with zip ties to easily hang and hide cables
 - Asymmetrical platforms feature connecting slots on both the long and short sides
- Wheel kit available for the 24" x 24" platform

SilverBack Applications

Ideal for:

- General Manufacturing
- Manual Batch Filling
- Shipping / Receiving
- Gross/Tare/Net Weighing
- Parts Counting
- Inventory Control



Specifications

Construction	Base: Mild Steel Shroud: 304 Stainless Steel	Finish	Base: Black Powder Coat Shroud: Brush Polish
Overload Protection	150%	Load Cell Specifications	
Resolution	5,000 d Commercial	Load Cell Rating	IP67
Feet	Height Adjustable, Rubber	Rated Output	2.0 mV/V +/- 0.2
Temperature Compensated Range	14° – 104° degrees F	Bridge Resistance	350 Ohm
Approvals	NTEP & FM Approval	Cable Length	10'



SilverBack (Gen 2) Carbon Steel Bench Scale Pricing

SilverBack GEN2 Carbon Steel Bench Scales

All SilverBack Gen 2 bench scales have NTEP & FM Approved IP67 load cells to 5,000 divisions

Product #	Description	Platform Size	Capacity	Weight	List Price
SB10977	SilverBack (Gen 2) Mild Steel Bench Scale - 10" x 10" Platform at 2 lbs Capacity	10" x 10"	2 lbs	lbs.	\$619.00
SB10978	SilverBack (Gen 2) Mild Steel Bench Scale - 10" x 10" Platform at 6 lbs Capacity	10" x 10"	6 lbs	lbs.	\$619.00
SB10979	SilverBack (Gen 2) Mild Steel Bench Scale - 10" x 10" Platform at 10 lbs Capacity	10" x 10"	10 lbs	lbs.	\$619.00
SB10980	SilverBack (Gen 2) Mild Steel Bench Scale - 10" x 10" Platform at 25 lbs Capacity	10" x 10"	25 lbs	lbs.	\$619.00
SB10981	SilverBack (Gen 2) Mild Steel Bench Scale - 10" x 10" Platform at 50 lbs Capacity	10" x 10"	50 lbs	lbs.	\$619.00
39233	SilverBack (Gen 2) Mild Steel Bench Scale - 12" X 12" Platform at 25 lbs Capacity	12" X 12"	25 lbs	19 lbs.	\$734.00
39234	SilverBack (Gen 2) Mild Steel Bench Scale - 12" X 12" Platform at 50 lbs Capacity	12" X 12"	50 lbs	19 lbs.	\$734.00
SB10982	SilverBack (Gen 2) Mild Steel Bench Scale - 12" x 12" Platform at 100 lbs Capacity	12" x 12"	100 lbs	lbs.	\$734.00
SB10983	SilverBack (Gen 2) Mild Steel Bench Scale - 12" x 12" Platform at 150 lbs Capacity	12" x 12"	150 lbs	lbs.	\$734.00
SB10984	SilverBack (Gen 2) Mild Steel Bench Scale - 12" x 12" Platform at 200 lbs Capacity	12" x 12"	200 lbs	lbs.	\$734.00
SB10985	SilverBack (Gen 2) Mild Steel Bench Scale - 12" x 12" Platform at 250 lbs Capacity	12" x 12"	250 lbs	lbs.	\$734.00
39236	SilverBack (Gen 2) Mild Steel Bench Scale - 12" X 16" Platform at 50 lbs Capacity	12" X 16"	50 lbs	24 lbs.	\$767.00
39235	SilverBack (Gen 2) Mild Steel Bench Scale - 12" X 16" Platform at 100 lbs Capacity	12" X 16"	100 lbs	24 lbs.	\$767.00
SB10986	SilverBack (Gen 2) Mild Steel Bench Scale - 14" x 14" Platform at 25 lbs Capacity	14" x 14"	25 lbs	lbs.	\$732.00
SB10987	SilverBack (Gen 2) Mild Steel Bench Scale - 14" x 14" Platform at 50 lbs Capacity	14" x 14"	50 lbs	lbs.	\$732.00
SB10988	SilverBack (Gen 2) Mild Steel Bench Scale - 14" x 14" Platform at 100 lbs Capacity	14" x 14"	100 lbs	lbs.	\$732.00
SB10989	SilverBack (Gen 2) Mild Steel Bench Scale - 14" x 14" Platform at 150 lbs Capacity	14" x 14"	150 lbs	lbs.	\$732.00
SB10990	SilverBack (Gen 2) Mild Steel Bench Scale - 14" x 14" Platform at 200 lbs Capacity	14" x 14"	200 lbs	lbs.	\$732.00
SB10991	SilverBack (Gen 2) Mild Steel Bench Scale - 14" x 14" Platform at 250 lbs Capacity	14" x 14"	250 lbs	lbs.	\$732.00
39238	SilverBack (Gen 2) Mild Steel Bench Scale - 15" X 15" Platform at 50 lbs Capacity	15" X 15"	50 lbs	29 lbs.	\$813.00
39237	SilverBack (Gen 2) Mild Steel Bench Scale - 15" X 15" Platform at 100 lbs Capacity	15" X 15"	100 lbs	29 lbs.	\$813.00
SB10992	SilverBack (Gen 2) Mild Steel Bench Scale - 15" x 15" Platform at 250 lbs Capacity	15" x 15"	250 lbs	lbs.	\$830.00
SB10993	SilverBack (Gen 2) Mild Steel Bench Scale - 16" x 16" Platform at 50 lbs Capacity	16" x 16"	50 lbs	lbs.	\$830.00
SB10994	SilverBack (Gen 2) Mild Steel Bench Scale - 16" x 16" Platform at 100 lbs Capacity	16" x 16"	100 lbs	lbs.	\$830.00
SB10995	SilverBack (Gen 2) Mild Steel Bench Scale - 16" x 16" Platform at 250 lbs Capacity	16" x 16"	250 lbs	lbs.	\$830.00
39239	SilverBack (Gen 2) Mild Steel Bench Scale - 16" X 18" Platform at 100 lbs Capacity	16" X 18"	100 lbs	48 lbs.	\$835.00
SB10996	SilverBack (Gen 2) Mild Steel Bench Scale - 16" x 18" Platform at 150 lbs Capacity	16" x 18"	150 lbs	lbs.	\$835.00
SB10997	SilverBack (Gen 2) Mild Steel Bench Scale - 16" x 18" Platform at 250 lbs Capacity	16" x 18"	250 lbs	lbs.	\$835.00



SilverBack GEN2 Carbon Steel Bench Scales (continued)

All SilverBack Gen 2 bench scales have NTEP & FM Approved IP67 load cells to 5,000 divisions

Product #	Description	Platform Size	Capacity	Weight	List Price
SB10998	SilverBack (Gen 2) Mild Steel Bench Scale - 18" x 18" Platform at 25 lbs Capacity	18" x 18"	25 lbs	lbs.	\$877.00
SB10999	SilverBack (Gen 2) Mild Steel Bench Scale - 18" x 18" Platform at 50 lbs Capacity	18" x 18"	50 lbs	lbs.	\$877.00
SB11000	SilverBack (Gen 2) Mild Steel Bench Scale - 18" x 18" Platform at 100 lbs Capacity	18" x 18"	100 lbs	lbs.	\$877.00
SB11001	SilverBack (Gen 2) Mild Steel Bench Scale - 18" x 18" Platform at 150 lbs Capacity	18" x 18"	150 lbs	lbs.	\$877.00
SB11002	SilverBack (Gen 2) Mild Steel Bench Scale - 18" x 18" Platform at 200 lbs Capacity	18" x 18"	200 lbs	lbs.	\$877.00
39241	SilverBack (Gen 2) Mild Steel Bench Scale - 18" X 18" Platform at 250 lbs Capacity	18" X 18"	250 lbs	65 lbs.	\$877.00
SB11003	SilverBack (Gen 2) Mild Steel Bench Scale - 18" x 18" Platform at 300 lbs Capacity	18" x 18"	300 lbs	lbs.	\$909.00
39242	SilverBack (Gen 2) Mild Steel Bench Scale - 18" X 18" Platform at 500 lbs Capacity	18" X 18"	500 lbs	65 lbs.	\$909.00
SB11004	SilverBack (Gen 2) Mild Steel Bench Scale - 18" x 18" Platform at 1000 lbs Capacity	18" x 18"	1000 lbs	lbs.	\$909.00
39243	SilverBack (Gen 2) Mild Steel Bench Scale - 18" X 24" Platform at 100 lbs Capacity	18" X 24"	100 lbs	79 lbs.	\$995.00
SB11005	SilverBack (Gen 2) Mild Steel Bench Scale - 18" x 24" Platform at 150 lbs Capacity	18" x 24"	150 lbs	lbs.	\$995.00
SB11006	SilverBack (Gen 2) Mild Steel Bench Scale - 18" x 24" Platform at 200 lbs Capacity	18" x 24"	200 lbs	lbs.	\$995.00
39244	SilverBack (Gen 2) Mild Steel Bench Scale - 18" X 24" Platform at 250 lbs Capacity	18" X 24"	250 lbs	79 lbs.	\$995.00
39245	SilverBack (Gen 2) Mild Steel Bench Scale - 18" X 24" Platform at 500 lbs Capacity	18" X 24"	500 lbs	79 lbs.	\$1,017.00
SB11007	SilverBack (Gen 2) Mild Steel Bench Scale - 18" x 24" Platform at 1000 lbs Capacity	18" x 24"	1000 lbs	lbs.	\$1,017.00
39246	SilverBack (Gen 2) Mild Steel Bench Scale - 24" X 24" Platform at 100 lbs Capacity	24" X 24"	100 lbs	120 lbs.	\$1,370.00
SB11008	SilverBack (Gen 2) Mild Steel Bench Scale - 24" x 24" Platform at 150 lbs Capacity	24" x 24"	150 lbs	lbs.	\$1,370.00
39247	SilverBack (Gen 2) Mild Steel Bench Scale - 24" X 24" Platform at 250 lbs Capacity	24" X 24"	250 lbs	120 lbs.	\$1,370.00
39248	SilverBack (Gen 2) Mild Steel Bench Scale - 24" X 24" Platform at 500 lbs Capacity	24" X 24"	500 lbs	120 lbs.	\$1,391.00
SB11009	SilverBack (Gen 2) Mild Steel Bench Scale - 24" x 24" Platform at 1000 lbs Capacity	24" x 24"	1000 lbs	lbs.	\$1,391.00

Available Pillars (Silverback GEN 2 Pillars)

See below for compatibility, pillar bolts directly to GEN 2 platform, mounting hardware included, comes with adjustable foot					
Product #	Description		Pillar Height	Weight	List Price
SB10166	Silverback (Gen 2) 10" Pillar	For all platform sizes	10"	lbs.	\$111.00
39287	Silverback (Gen 2) 12" Pillar	For all size platforms	12"	7 lbs.	\$120.00
SB10167	Silverback (Gen 2) 18" Pillar	For 15" x 15" or larger platforms	18"	lbs.	\$147.00
39289	Silverback (Gen 2) 24" Pillar	For 16" x 18" and larger platforms	24"	11 lbs.	\$168.00
SB10168	Silverback (Gen 2) 30" Pillar	For 18" or larger platforms	30"	lbs.	\$172.00

Available Accessories

Product #	Description	Weight	List Price
22615	FACTORY CALIBRATION OF INSTRUMENT		\$76.00
18245	ACC 5000 , Wheel kit for 24" x 24" QuickSilver & SilverBack Bench Scales	10 lbs.	\$319.00
26041	10' RS232 INTERFACE CABLE	3 lbs.	\$117.00
38797	Certificate of Compliance for Factory Calibration		\$91.00



SilverBack Bench Scale Kits w/ Resin Alloy FB1200

SilverBack Bench Scale Kits w/ Resin Alloy FB1200

Kit includes one (1) SilverBack Platform, one (1) Pillar & one (1) Resin Alloy FB1200 instrument

Product #	Description	Platform Size	Capacity	Pillar Size	Individual Piece List Price	Kit List Price
SB10132	SilverBack (Gen 2) Mild Steel Bench Scale - 12" X 12" Platform at 25 lbs Capacity Package Includes PN's 39233, 38041 & 39287	12" X 12"	25 lbs.	12"	\$1,527.00	\$1,482.00
SB10133	SilverBack (Gen 2) Mild Steel Bench Scale - 12" X 12" Platform at 50 lbs Capacity Package Includes PN's 39234, 38041 & 39287	12" X 12"	50 lbs.	12"	\$1,527.00	\$1,482.00
SB10134	SilverBack (Gen 2) Mild Steel Bench Scale - 12" X 16" Platform at 50 lbs Capacity Package Includes PN's 39236, 38041 & 39287	12" X 16"	50 lbs.	12"	\$1,560.00	\$1,514.00
SB10135	SilverBack (Gen 2) Mild Steel Bench Scale - 12" X 16" Platform at 100 lbs Capacity Package Includes PN's 39235, 38041 & 39287	12" X 16"	100 lbs.	12"	\$1,560.00	\$1,514.00
SB10136	SilverBack (Gen 2) Mild Steel Bench Scale - 15" X 15" Platform at 50 lbs Capacity Package Includes PN's 39238, 38041 & 39287	15" X 15"	50 lbs.	12"	\$1,606.00	\$1,558.00
SB10137	SilverBack (Gen 2) Mild Steel Bench Scale - 15" X 15" Platform at 100 lbs Capacity Package Includes PN's 39237, 38041 & 39287	15" X 15"	100 lbs.	12"	\$1,606.00	\$1,558.00
SB10138	SilverBack (Gen 2) Mild Steel Bench Scale - 16" X 18" Platform at 100 lbs Capacity Package Includes PN's 39239, 38041 & 39289	16" X 18"	100 lbs.	24"	\$1,676.00	\$1,626.00
SB10139	SilverBack (Gen 2) Mild Steel Bench Scale - 18" X 18" Platform at 100 lbs Capacity Package Includes PN's 39240, 38041 & 39289	18" X 18"	100 lbs.	24"	\$1,718.00	\$1,667.00
SB10140	SilverBack (Gen 2) Mild Steel Bench Scale - 18" X 18" Platform at 250 lbs Capacity Package Includes PN's 39241, 38041 & 39289	18" X 18"	250 lbs.	24"	\$1,718.00	\$1,667.00
SB10141	SilverBack (Gen 2) Mild Steel Bench Scale - 18" X 18" Platform at 500 lbs Capacity Package Includes PN's 39242, 38041 & 39289	18" X 18"	500 lbs.	24"	\$1,750.00	\$1,698.00
SB10142	SilverBack (Gen 2) Mild Steel Bench Scale - 18" X 24" Platform at 100 lbs Capacity Package Includes PN's 39243, 38041 & 39289	18" X 24"	100 lbs.	24"	\$1,836.00	\$1,781.00
SB10143	SilverBack (Gen 2) Mild Steel Bench Scale - 18" X 24" Platform at 250 lbs Capacity Package Includes PN's 39244, 38041 & 39289	18" X 24"	250 lbs.	24"	\$1,836.00	\$1,781.00
SB10144	SilverBack (Gen 2) Mild Steel Bench Scale - 18" X 24" Platform at 500 lbs Capacity Package Includes PN's 39245, 38041 & 39289	18" X 24"	500 lbs.	24"	\$1,858.00	\$1,803.00
SB10145	SilverBack (Gen 2) Mild Steel Bench Scale - 24" X 24" Platform at 100 lbs Capacity Package Includes PN's 39246, 38041 & 39289	24" X 24"	100 lbs.	24"	\$2,211.00	\$2,145.00
SB10146	SilverBack (Gen 2) Mild Steel Bench Scale - 24" X 24" Platform at 250 lbs Capacity Package Includes PN's 39247, 38041 & 39289	24" X 24"	250 lbs.	24"	\$2,211.00	\$2,145.00
SB10147	SilverBack (Gen 2) Mild Steel Bench Scale - 24" X 24" Platform at 500 lbs Capacity Package Includes PN's 39248, 38041 & 39289	24" X 24"	500 lbs.	24"	\$2,232.00	\$2,166.00
Product #	Description				Individual Piece List Price	Kit List Price
38047	FB1200 BATTERY MODULE				\$306.00	\$301.00
22615	FACTORY CALIBRATION OF INSTRUMENT				\$76.00	\$71.00



SilverBack Bench Scale Kits w/ Stainless Steel FB1200

SilverBack Bench Scale Kits w/ Stainless Steel FB1200

Kit includes one (1) SilverBack Platform, one (1) Pillar, one (1) Stainless Steel FB1200 instrument

Product #	Description	Platform Size	Capacity	Pillar Size	Individual Piece List Price	Kit List Price
SB10148	SilverBack (Gen 2) Mild Steel Bench Scale - 12" X 12" Platform at 25 lbs Capacity Package Includes PN's 39233, 38009 & 39287	12" X 12"	25 lbs.	12"	\$1,753.00	\$1,701.00
SB10149	SilverBack (Gen 2) Mild Steel Bench Scale - 12" X 12" Platform at 50 lbs Capacity Package Includes PN's 39234, 38009 & 39287	12" X 12"	50 lbs.	12"	\$1,753.00	\$1,701.00
SB10150	SilverBack (Gen 2) Mild Steel Bench Scale - 12" X 16" Platform at 50 lbs Capacity Package Includes PN's 39236, 38009 & 39287	12" X 16"	50 lbs.	12"	\$1,786.00	\$1,733.00
SB10151	SilverBack (Gen 2) Mild Steel Bench Scale - 12" X 16" Platform at 100 lbs Capacity Package Includes PN's 39235, 38009 & 39287	12" X 16"	100 lbs.	12"	\$1,786.00	\$1,733.00
SB10152	SilverBack (Gen 2) Mild Steel Bench Scale - 15" X 15" Platform at 50 lbs Capacity Package Includes PN's 39238, 38009 & 39287	15" X 15"	50 lbs.	12"	\$1,832.00	\$1,778.00
SB10153	SilverBack (Gen 2) Mild Steel Bench Scale - 15" X 15" Platform at 100 lbs Capacity Package Includes PN's 39237, 38009 & 39287	15" X 15"	100 lbs.	12"	\$1,832.00	\$1,778.00
SB10154	SilverBack (Gen 2) Mild Steel Bench Scale - 16" X 18" Platform at 100 lbs Capacity Package Includes PN's 39239, 38009 & 39289	16" X 18"	100 lbs.	24"	\$1,902.00	\$1,845.00
SB10155	SilverBack (Gen 2) Mild Steel Bench Scale - 18" X 18" Platform at 100 lbs Capacity Package Includes PN's 39240, 38009 & 39289	18" X 18"	100 lbs.	24"	\$1,944.00	\$1,886.00
SB10156	SilverBack (Gen 2) Mild Steel Bench Scale - 18" X 18" Platform at 250 lbs Capacity Package Includes PN's 39241, 38009 & 39289	18" X 18"	250 lbs.	24"	\$1,944.00	\$1,886.00
SB10157	SilverBack (Gen 2) Mild Steel Bench Scale - 18" X 18" Platform at 500 lbs Capacity Package Includes PN's 39242, 38009 & 39289	18" X 18"	500 lbs.	24"	\$1,976.00	\$1,917.00
SB10158	SilverBack (Gen 2) Mild Steel Bench Scale - 18" X 24" Platform at 100 lbs Capacity Package Includes PN's 39243, 38009 & 39289	18" X 24"	100 lbs.	24"	\$2,062.00	\$2,001.00
SB10159	SilverBack (Gen 2) Mild Steel Bench Scale - 18" X 24" Platform at 250 lbs Capacity Package Includes PN's 39244, 38009 & 39289	18" X 24"	250 lbs.	24"	\$2,062.00	\$2,001.00
SB10160	SilverBack (Gen 2) Mild Steel Bench Scale - 18" X 24" Platform at 500 lbs Capacity Package Includes PN's 39245, 38009 & 39289	18" X 24"	500 lbs.	24"	\$2,084.00	\$2,022.00
SB10161	SilverBack (Gen 2) Mild Steel Bench Scale - 24" X 24" Platform at 100 lbs Capacity Package Includes PN's 39246, 38009 & 39289	24" X 24"	100 lbs.	24"	\$2,437.00	\$2,364.00
SB10162	SilverBack (Gen 2) Mild Steel Bench Scale - 24" X 24" Platform at 250 lbs Capacity Package Includes PN's 39247, 38009 & 39289	24" X 24"	250 lbs.	24"	\$2,437.00	\$2,364.00
SB10163	SilverBack (Gen 2) Mild Steel Bench Scale - 24" X 24" Platform at 500 lbs Capacity Package Includes PN's 39248, 38009 & 39289	24" X 24"	500 lbs.	24"	\$2,458.00	\$2,385.00
Product #	Description				Individual Piece List Price	Kit List Price
38047	FB1200 BATTERY MODULE				\$306.00	\$301.00
22615	FACTORY CALIBRATION OF INSTRUMENT				\$76.00	\$71.00



SilverBack Bench Scale Kits w/ FB2250s & NexWeigh Instruments

SilverBack Bench Scale Kits w/ ABS FB2255 Instrument (with Battery Kit)

Kit includes one (1) SilverBack Platform, one (1) Pillar, one (1) FB2255 ABS with AC/Battery Power

Product #	Description	Platform Size	Capacity	Pillar Size	Individual Piece List Price	Kit List Price
SB10180	SilverBack (Gen 2) Mild Steel Bench Scale - 12" X 12" Platform at 50 lbs Capacity Package Includes PN's 39234, 32449 & 39287	12" X 12"	50 lbs.	12"	\$2,249.00	\$2,182.00
SB10181	SilverBack (Gen 2) Mild Steel Bench Scale - 16" X 18" Platform at 100 lbs Capacity Package Includes PN's 39239, 32449 & 39289	16" X 18"	100 lbs.	24"	\$2,398.00	\$2,327.00
SB10182	SilverBack (Gen 2) Mild Steel Bench Scale - 18" X 18" Platform at 250 lbs Capacity Package Includes PN's 39241, 32449 & 39289	18" X 18"	250 lbs.	24"	\$2,440.00	\$2,367.00
SB10183	SilverBack (Gen 2) Mild Steel Bench Scale - 24" X 24" Platform at 500 lbs Capacity Package Includes PN's 39248, 32449 & 39289	24" X 24"	500 lbs.	24"	\$2,954.00	\$2,866.00

SilverBack Bench Scale Kits w/ Stainless Steel FB2255 Instrument

Kit includes one (1) SilverBack Platform, one (1) Pillar, one (1) Stainless Steel FB2255 NEMA 4X Instrument

Product #	Description	Platform Size	Capacity	Pillar Size	Individual Piece List Price	Kit List Price
SB10184	SilverBack (Gen 2) Mild Steel Bench Scale - 12" X 12" Platform at 50 lbs Capacity Package Includes PN's 39234, 32450 & 39287	12" X 12"	50 lbs.	12"	\$3,267.00	\$3,169.00
SB10185	SilverBack (Gen 2) Mild Steel Bench Scale - 16" X 18" Platform at 100 lbs Capacity Package Includes PN's 39239, 32450 & 39289	16" X 18"	100 lbs.	24"	\$3,416.00	\$3,314.00
SB10186	SilverBack (Gen 2) Mild Steel Bench Scale - 18" X 18" Platform at 250 lbs Capacity Package Includes PN's 39241, 32450 & 39289	18" X 18"	250 lbs.	24"	\$3,458.00	\$3,355.00
SB10187	SilverBack (Gen 2) Mild Steel Bench Scale - 24" X 24" Platform at 500 lbs Capacity Package Includes PN's 39248, 32450 & 39289	24" X 24"	500 lbs.	24"	\$3,972.00	\$3,853.00

SilverBack Bench Scale Kits w/ Stainless Steel NexWeigh Instrument

Kit includes one (1) SilverBack Platform, one (1) Pillar, one (1) Stainless Steel NexWeigh NEMA 4X Instrument

Product #	Description	Platform Size	Capacity	Pillar Size	Individual Piece List Price	Kit List Price
SB10188	SilverBack (Gen 2) Mild Steel Bench Scale - 12" X 12" Platform at 50 lbs Capacity Package Includes PN's 39234, 29757 & 39287	12" X 12"	50 lbs.	12"	\$2,524.00	\$2,449.00
SB10189	SilverBack (Gen 2) Mild Steel Bench Scale - 16" X 18" Platform at 100 lbs Capacity Package Includes PN's 39239, 29757 & 39289	16" X 18"	100 lbs.	24"	\$2,673.00	\$2,593.00
SB10190	SilverBack (Gen 2) Mild Steel Bench Scale - 18" X 18" Platform at 250 lbs Capacity Package Includes PN's 39241, 29757 & 39289	18" X 18"	250 lbs.	24"	\$2,715.00	\$2,634.00
SB10191	SilverBack (Gen 2) Mild Steel Bench Scale - 24" X 24" Platform at 500 lbs Capacity Package Includes PN's 39248, 29757 & 39289	24" X 24"	500 lbs.	24"	\$3,229.00	\$3,133.00

Product #	Description	Individual Piece List Price	Kit List Price
22615	FACTORY CALIBRATION OF INSTRUMENT	\$76.00	\$71.00



How to build a Stainless Steel Washdown Bench Scale

1 - Quicksilver Platform

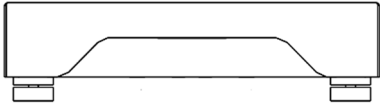

Step 1 –
Choose your platform

Page 12

2 - Instrument

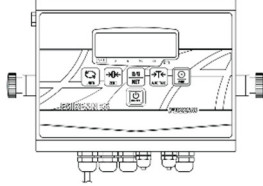

Step 2 –
Choose your instrument

Pages 14-16

2a - Power Source for QuickSilver Intrinsically Safe Instrument

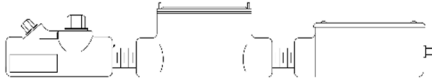

Step 2a –
Power Source for QuickSilver
Intrinsically Safe Instrument

Page 16

3 - Pillar Kit or Bracket

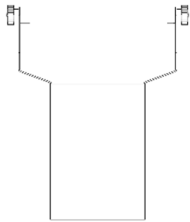

Step 3 –
Add pillar or bracket

Page 13

4 - Accessories to specialize the Bench Scale

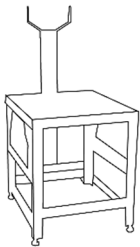

Step 4 –
Add any accessories
to specialize the
bench scale

Page 13

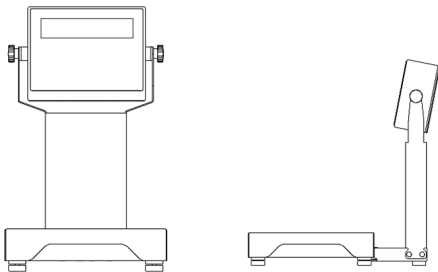

= The Best and *Most*
Flexible Stainless Steel
Washdown Bench Scale



The mechanical design of the QuickSilver Platforms follows sanitary specifications for processing equipment developed by the AMI's Sanitary Equipment Design Task Force. Every detail of the QuickSilver has been examined and designed to reduce the potential for colonization by harmful microbes, such as listeria monocytogenes and E. coli. The QuickSilver platforms can be cleaned to a microbiological level. This product will improve sanitation audit scores and increase overall food safety in any facility.

The Best Sanitary Scale Platform on the Market

- Engineered to meet the AMI's 10 principles of Sanitary Design
- Exceeds sanitation needs of most pharmaceutical & chemical applications
- Designed for heavy washdown applications
- Constructed of 304 Series Stainless Steel
- Compatible with all Fairbanks analog instruments, as well as analog instruments produced by other manufacturers

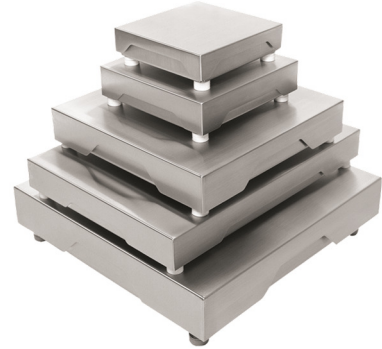

QuickSilver Platforms

- Sizes range from 10" x 10" up to 24" x 24"
- Capacities from 2 lbs. up to 1,000 lbs.
- Cleaning SOP included with the service/installation manual
- Load cell options:
 - Stainless Steel IP69K
 - Stainless Steel NEMA 4X
 - Aluminum IP67
- Optimal scale for both high-pressure and high-temp environments

AMI's 10 Principles of Sanitary Design

- | | |
|---|--|
| <ul style="list-style-type: none"> • Cleanable to a micro-biologic level • No product or liquid collection • Sanitary operational performance • Hollow areas hermetically sealed • Made of compatible components | <ul style="list-style-type: none"> • Hygienic compatibility with other plant systems • Accessible for inspection, maintenance, cleaning and sanitation • No niches • Hygienic design of maintenance enclosures • Validate cleaning and sanitizing protocols |
|---|--|

Applications: Ideal for food, chemical and pharmaceutical applications. RTE wash-down, food wash-down, Gross/Tare/Net weighing, manual batching / filling / blending

QuickSilver Platform Pricing

	Specifications	
	Construction	304 Stainless Steel
	Finish	Brush Polish
	Overload Capacity	300% (500% on 24" x 24")
	Feet	Food grade, height adjustable
	Temperature Compensated Range	-14° to 104° degrees F
	LOAD CELLS SPECIFICATIONS	
	Rated Output	2.0 mv/V +/-0.2%
	Bridge Resistance	350 ohm (1000 ohms on Hermitically Sealed cells)
	Cable Length	5' on 12" x 12" and smaller 10' on 18" x 18" and larger

QuickSilver Platforms

Product #	Description	Platform Size	Load Cell Construction	Load Cell Protection	Weight	List Price
24760	QUICKSILVER 10 x 10 2 LB CAP WITH Stainless Steel IP67 Load Cell	10" x 10"	Stainless Steel	IP67	16 lbs.	\$773.00
24761	QUICKSILVER 10 x 10 6 LB CAP WITH Stainless Steel IP67 Load Cell	10" x 10"	Stainless Steel	IP67	16 lbs.	\$773.00
24762	QUICKSILVER 10 x 10, 10 LB CAP WITH Stainless Steel IP67 Load Cell	10" x 10"	Stainless Steel	IP67	16 lbs.	\$773.00
24763	QUICKSILVER 10 x 10, 25 LB CAP WITH Stainless Steel IP67 Load Cell	10" x 10"	Stainless Steel	IP67	16 lbs.	\$773.00
24764	QUICKSILVER 12x12 30 LB CAP WITH Stainless Steel IP67 Load Cell	12" x 12"	Stainless Steel	IP67	40 lbs.	\$943.00
24765	QUICKSILVER,12X12,50 LB CAP WITH Stainless Steel IP67 Load Cell	12" x 12"	Stainless Steel	IP67	40 lbs.	\$943.00
26029	QUICKSILVER 12 x 12, 100 LB CAP WITH Stainless Steel IP67 Load Cell	12" x 12"	Stainless Steel	IP67	40 lbs.	\$943.00
24766	QUICKSILVER,18X18,50 LB CAP WITH Stainless Steel IP67 Load Cell	18" x 18"	Stainless Steel	IP67	46 lbs.	\$1,332.00
24767	QUICKSILVER,18X18,100 LB CAP WITH Stainless Steel IP67 Load Cell	18" x 18"	Stainless Steel	IP67	46 lbs.	\$1,332.00
24768	QUICKSILVER,18X18,150 LB CAP WITH Stainless Steel IP67 Load Cell	18" x 18"	Stainless Steel	IP67	46 lbs.	\$1,462.00
24769	QUICKSILVER,18X18,300 LB CAP WITH Stainless Steel IP67 Load Cell	18" x 18"	Stainless Steel	IP67	50 lbs.	\$1,462.00
24770	QUICKSILVER,18X24,100 LB CAP WITH Aluminum IP66 Load Cell	18" x 24"	Aluminum	IP66	98 lbs.	\$1,724.00
24771	QUICKSILVER,18X24,150 LB CAP WITH Aluminum IP66 Load Cell	18" x 24"	Aluminum	IP66	98 lbs.	\$1,856.00
24772	QUICKSILVER,18X24,200 LB CAP WITH Aluminum IP66 Load Cell	18" x 24"	Aluminum	IP66	98 lbs.	\$1,882.00
24773	QUICKSILVER,24X24,100 LB CAP WITH Aluminum IP66 Load Cell	24" x 24"	Aluminum	IP66	131 lbs.	\$2,043.00
24774	QUICKSILVER,24X24,250 LB CAP WITH Aluminum IP66 Load Cell	24" x 24"	Aluminum	IP66	131 lbs.	\$2,043.00
24775	QUICKSILVER,24X24,500 LB CAP WITH Aluminum IP66 Load Cell	24" x 24"	Aluminum	IP66	131 lbs.	\$2,255.00
24776	QUICKSILVER,24X24,1000 LB CAP WITH Aluminum IP66 Load Cell	24" x 24"	Aluminum	IP66	131 lbs.	\$2,284.00
24862	QUICKSILVER 18 x 24 100 LB CAP WITH Stainless Steel IP69K Load Cell	18" x 24"	Stainless Steel	IP69K	98 lbs.	\$2,563.00
24863	QUICKSILVER 18X24 150 LB CAP WITH Stainless Steel IP69K Load Cell	18" x 24"	Stainless Steel	IP69K	98 lbs.	\$2,708.00
24864	QUICKSILVER,18X24,200 LB CAP WITH Stainless Steel IP69K Load Cell	18" x 24"	Stainless Steel	IP69K	98 lbs.	\$2,735.00
24783	QUICKSILVER 24 x 24, 100 LB CAP WITH Stainless Steel IP69K Load Cell	24" x 24"	Stainless Steel	IP69K	131 lbs.	\$3,196.00
24784	QUICKSILVER 24x24 250 LB CAP WITH Stainless Steel IP69K Load Cell	24" x 24"	Stainless Steel	IP69K	131 lbs.	\$3,196.00
24785	QUICKSILVER 24x24 500 LB CAP WITH Stainless Steel IP69K Load Cell	24" x 24"	Stainless Steel	IP69K	131 lbs.	\$3,196.00
24786	QUICKSILVER 24 x 24 1000 LB CAP WITH Stainless Steel IP69K Load Cell	24" x 24"	Stainless Steel	IP69K	131 lbs.	\$3,196.00

QuickSilver Pillars



QuickSilver Pillars

Product #	Description	Pillar Height	Weight	List Price
27749	10" PILLAR FOR 10" x 10" & 12"x 12" PLATFORMS FOR FB2250, FB2255 & NEXWEIGH	10"	6 lbs	\$145.00
27750	18" PILLAR; 12"x12" THRU 18"x 24" PLATFORMS FOR FB2250, FB2255 & NEXWEIGH	18"	10 lbs	\$195.00
27751	18" PILLAR, 24" x 24" PLATFORMS FOR FB2250, FB2255 & NEXWEIGH	18"	13 lbs	\$195.00
27752	30" PILLAR FOR 18"x 24" PLATFORMS FOR FB2250, FB2255 & NEXWEIGH	30"	16 lbs	\$295.00
27753	30" PILLAR FOR 24"x 24" PLATFORMS FOR FB2250, FB2255 & NEXWEIGH	30"	21 lbs	\$295.00
27744	SHORT PILLAR/TILT BRACKET		4 lbs	\$130.00
27743	DESK/WALL MOUNT STAND		2 lbs	\$130.00

Bench Scale Stands

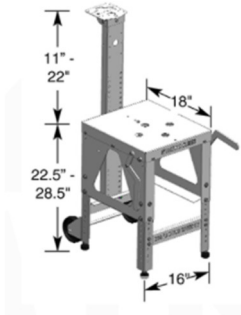

Bench Scale Stands

Part #	Description	Weight	List Price
29600	STAINLESS STEEL BENCH STAND SM	40 lbs	\$747.00
29601	STAINLESS STEEL BENCH STAND LG	60 lbs	\$908.00

Bench Scale Stand Accessories

Part #	Description	Weight	List Price
29753	BENCH STAND PILLAR/YOKE KIT	15 lbs	\$212.00
29754	BENCH STAND PILLAR/PLATE KIT	15 lbs	\$212.00
29752	SS BENCHSTAND PILLAR/BRKT KIT	15 lbs	\$207.00
29767	9" SS PILLAR EXTENSION	5 lbs	\$85.00
29614	WHEEL KIT FOR SMALL SS STAND	10 lbs	\$258.00
29751	WHEEL KIT FOR LARGE SS STAND	15 lbs	\$295.00

Capacity	COMMERCIAL DIVISION SIZE		NON-COMMERCIAL DIVISION SIZE	
	LB (Pounds)	Kgs (Kilograms)	LB (Pounds)	Kgs (Kilograms)
2 lbs.	N/A	N/A	2 X 0.0005	1 X 0.0002
6 lbs.	6 X 0.002	2 X 0.001	6 X 0.001	2 X 0.0005
10 lbs.	10 X 0.002	4 X 0.001	10 X 0.001	4 X 0.0005
25 lbs.	25 X 0.005	11 X 0.002	25 X 0.002	11 X 0.002
30 lbs.	30 X 0.01	13 X 0.005	30 X 0.005	13 X 0.002
50 lbs.	50 X 0.01	22 X 0.005	50 X 0.005	22 X 0.005
100 lbs.	100 X 0.02	45 X 0.01	100 X 0.01	45 X 0.005
150 lbs.	150 X 0.05	68 X 0.02	150 X 0.02	68 X 0.01
200 lbs.	200 X 0.05	90 X 0.02	200 X 0.02	90 X 0.01
250 lbs.	250 X 0.05	113 X 0.02	250 X 0.02	113 X 0.01
300 lbs.	300 X 0.1	136 X 0.05	300 X 0.05	136 X 0.02
500 lbs.	500 X 0.1	226 X 0.05	500 X 0.1	226 X 0.05
1000 lbs.	1000 X 0.2	452 X 0.1	1000 X 0.1	452 X 0.05

Note: The matrix above defaults to the QuickSilver Platform commercial rating where applicable.

When used with a different platform, consult the proper commercial rating for that specific platform

SEE THE NEXUS PLATFORM FOR UP-TO-DATE DIVISION INFORMATION FOR EACH PLATFORM/INSTRUMENTS

QuickSilver Instruments

FB1200 (Stainless Steel)



Product #	Description	Weight	List Price
38009	FB1200 STAINLESS STEEL ENCLOSURE, AC POWERED	15 lbs.	\$899.00
38047	FB1200 BATTERY MODULE	2 lbs.	\$306.00

FB2250



Product #	Description	Weight	List Price
29563	FB2250 INSTRUMENT, SS NEMA 4X	12 lbs.	\$1,410.00
29564	FB2250 INSTRUMENT, SS NEMA 4X	15 lbs.	\$2,121.00
29013	FB2250 INSTRUMENT, SS IP69K	13 lbs.	\$1,656.00

FB2255



Product #	Description	Weight	List Price
32451	FB2255 INST SS NEMA 4X, AC PWR (NO STAND)	15 lbs.	\$1,531.00
32452	FB2255 INST SS NEMA4X AC/BATT (NO STAND)	15 lbs.	\$2,242.00
32453	FB2255 INST SS ENCL IP69K (NO STAND)	13 lbs.	\$1,776.00

For Product Specifications – See Nexus product pages for complete information on each unit
See page 15 for general specs, features & comparisons

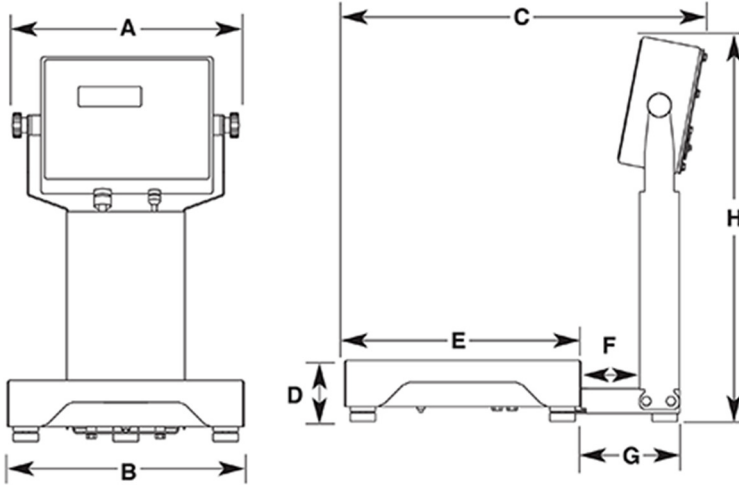

Notes:

- Adjustable feet for leveling add additional height of up to 0.05"
- FB225X = FB2250 and FB2255

- *4.12 for 300 lb model

Platform	A				B	C	D	E	F	G	H				
	FB1200 NEMA 4	FB1200 NEMA 4X	FB225X NexWeigh	QSI							FB225X		NexWeigh		QSI
											NEMA 4X	IP69K	NEMA 4X	IP69K	
10" x 10"	12.899"	12.702"	12.63"	11.43"	10"	16.37"	2.89"	10"	2.98"	4.98"	19.75" 10" pillar	19.88" 10" pillar	19.75" 10" pillar	19.88" 10" pillar	20.45" 10" pillar
12" x 12"	12.899"	12.702"	12.63"	11.43"	12"	18.37"	3.1"	12"	2.98"	4.98"	27.70" 18" pillar	27.83" 18" pillar	27.70" 18" pillar	27.83" 18" pillar	28.45" 18" pillar
18" x 18"	12.899"	12.702"	12.63"	11.43"	18"	24.37"	3.87" *	18"	2.98"	4.98"	39.75" 30" pillar	39.88" 30" pillar	39.75" 30" pillar	39.88" 30" pillar	40.45" 30" pillar
18" x 24"	12.899"	12.702"	12.63"	11.43"	18"	30.15"	5.06"	24"	2.76"	4.76"	40.77" 30" pillar	40.90" 30" pillar	40.77" 30" pillar	40.90" 30" pillar	41.47" 30" pillar
24" x 24"	12.899"	12.702"	12.63"	11.43"	24"	30.06"	5.77"	24"	2.67"	4.67"					
24" x 24"	12.899"	12.702"	12.63"	11.43"	24"	30.06"	5.77"	24"	2.67"	4.67"					

FAIRBANKS INDUSTRIAL INSTRUMENTS COMPARISON

FEATURE		FB1200	FB2250	FB2255	NexWeigh
DISPLAY:	SIZE	2"	1"	1"	1¼"
	DIGITS	6	7	7	6
	DISPLAY TYPE:	INVERTED LCD	GREEN LCD	GREEN LCD	AMBER LED
ENCLOSURE TYPES:		RESIN ALLOY STAINLESS STEEL	ABS STAINLESS STEEL	ABS STAINLESS STEEL	STAINLESS STEEL
ENCLOSURE RATINGS:		NEMA 4 NEMA 4X	NEMA 1, NEMA 4X & IP69K	NEMA 1, NEMA 4X & IP69K	NEMA 4X IP69K
CAPACITY		0 TO 999,999	0 TO 999,999	0 TO 999,999	0 TO 999,999
GRADUATION SIZE		0.0001 TO 100	0.0001 TO 50	0.0001 TO 50	0.0001 TO 50
POWER:	POWER REQUIREMENTS	AC/DC/BATTERY	AC/BATTERY	AC/BATTERY	AC
	POWER SPECIFICATIONS	100VAC/240VAC	115VAC/220VAC	115VAC/220VAC	110VAC/220VAC
TIME AND DATE		SELECTABLE	AM/PM, MM/DD/YYYY	AM/PM, MM/DD/YYYY	AM/PM, MM/DD/YYYY
UNITS:	STANDARD	LB, KG, OZ, G, LB-OZ, t, T	LB, KG, OZ, G, LB-OZ	LB, KG, OZ, G, LB-OZ	LB, KG, OZ, G, LB-OZ
	CUSTOM	✓	✓	✓	✓
# OF LOAD CELLS		(8) 350Ω or (16) 1,000Ω	(8) 350Ω or (16) 1,000Ω	(8) 350Ω or (16) 1,000Ω	(4) 350Ω or (8) 1,000Ω
CUSTOM FORMATTING FOR TICKETS/LABELS		✓	✓	✓	✗
REMOTE SWITCH INPUT		(2) SELECTABLE	5	5	3
PUSH BUTTON KEY		7	6	21	11
FULL NUMERIC KEYPAD		✗	✗	✓	✗
SLEEP MODE		✓	✓	✓	✗
OUTPUTS:	# OF OUTPUTS	COM1/COM2	COM1/COM2	COM1/COM2	COM1/COM2
	DIGITAL (RELAY) OUTPUTS	2	✗	✗	✗
	AVAIL. ACCESSORY ETHERNET TCP/IP	✗	✓	✓	✓
	20mA - Serial	1	1	1	✗
	AVAIL. ACCESSORY 4-20mA	✗	✓	✓	✓
	RS232	2	2	2	1
	RS485	1	2	2	1
	AVAIL. ACCESSORY- PLC INTERFACE	✗	✓	✓	✗
	CONFIG. SERIAL OUTPUT	✓	✓	✓	✗
	SET POINTS	2	✗	✗	✗
MODES OF OPERATION:	ACCUMULATION	✓	✓	✓	✓
	PIECE COUNT	✓	✓	✓	✗
	STRESS TEST/PEAK HOLD	✓	✓	✓	✓
	CHECKWEIGHING	BASIC/HIGH/OK/LOW	✗	✗	FULL
	LIVESTOCK FILTER	✓	✓	✓	✗
	REMOTE DISPLAY MODE	✓	✓	✓	✗
	AUTO TARE	✓	✓	✓	✗
	AUTO PRINT	✓	✓	✓	✓
	MULTI-POINT CALIBRATION	✓	✓	✓	✓
	PC/WEB UTILITY/VIEWER	✓	✓	✓	✗
CONNECTS TO VIEWER UTILITY WITHOUT OPENING INSTRUMENT		✓	✗	✗	✗
APPROVALS:		NTEP / MC	NTEP / MC	NTEP / MC	NTEP / MC



QuickSilver Intrinsicly Safe Instrument & Power Source

QuickSilver Intrinsicly Safe Instrument	
Specifications	
Display	.75" tall, 6 digit, 7 segment liquid crystal display
Filtering	4 levels for vibration suppression
AID conversion	8 updates per second
Controls	Auto tare, gross/net, units & zero
Units	Lb., kgs, oz & gram
Zero	+/- 2% or 100% of scale capacity
Auto Zero Tracking	Off; 0.5, 1 or 3 divisions
Power	7-volt rechargeable lead-acid battery pack, 65 hours continuous or 250 hours if in save mode
Accessories	Direct power supply
Approvals	FM, CSA, NTEP & MC
Material	304 stainless steel enclosure



QuickSilver I.S. Instrument

Product #	Description	Weight	List Price
25224	QUICKSILVER I.S. INST HR5001-1 <ul style="list-style-type: none"> • NEMA 4X enclosure WITHOUT stand • Must be ordered with battery (14617) and recharger (31465) or FM Approved direct power Supply (14177) <p>→ 25224 FM Approved QGIS instruments manufactured on or after 3/1/2018 are NOT approved for Division 1 applications. This is NOT applicable to 25546 CSA-Approved QGIS instruments</p>	40 lbs	\$1,721.00
Product #	Description	Weight	List Price
25546	QUICKSILVER I.S. INSTRUMENT <ul style="list-style-type: none"> • NEMA 4X enclosure WITHOUT stand • Must be ordered with battery (14617) and recharger (31465) or FM Approved direct power Supply (14177) 	40 lbs	\$1,721.00
Product #	Description		List Price
14617	BATTERY FOR H90-3052/HR5001 - (352 ACC BATTERY-H90-3052)		\$392.00
14619	BATTERY FOR H90-3052C/HR5001C - (352C ACC - CSA VERSION)		\$392.00
31465	530 ACC BATTERY CHARGER - FOR 352 BATTERY PACKS		\$632.00
25225	BATTERY BRACKET FOR QGIS - New Style Battery Bracket for 352 Battery		\$79.00

Ultegra Series Scales

Ultegra Shipping Scale

There are over 100,000 Ultegra scales in use today. It is a hugely popular choice in mail rooms and shipping operations worldwide. This rugged and reliable scale is also suited for use in a variety of other non-washdown general weighing applications up to 150 lbs.



Enclosure Type: ABS Composite

- NTEP approved
- Powered via USB, meaning only one cable for power & communication
- ABS composite shell with molded structural skeleton, which means while it only weighs 11 lbs., but it can withstand accidental overloads of 450-pound items
- UPS Worldship compatible

Specifications	Ultegra II	Ultegra Max
Capacity	150 lbs. (67.5 kg)	250 lbs. (113 kg)
Division Size	0.05 lbs.	0.05 lbs.
Output	USB (includes 6' cable)	USB (includes 6' cable)
Power Requirements	USB Powered, optional AC to USB adapter	USB Powered, optional AC to USB adapter
Display	0.5" high LCD	0.5" high LCD
Units	Pounds and kilograms	Pounds and kilograms
Construction	Gray ABS Composite	Mild steel, black powder coated
Accessories	Remote Display, Remote Display Pillar, AC to USB adapter, Counter Insert	Remote Display, Remote Display Pillar, AC to USB adapter

Pricing

Ultegra

Product #	Description	Length	Width	Height	Capacity	Weight	List Price
29824C	ULTEGRA II FLAT TOP 14"x14"	14"	14"	2.4"	150 lbs	11 lbs	\$460.00
30102C	ULTEGRA II 150LB ROLLTOP SCALE	14"	14"	3.57"	150 lbs	18 lbs	\$720.00

Ultegra MAX

Product #	Description	Length	Width	Height	Capacity	Weight	List Price
31081C	ULTEGRA MAX, FLAT TOP RoHS	21"	21"	2.5"	250 lbs	47 lbs	\$907.00
31082C	ULTEGRA MAX, ROLLER TOP RoHS	21"	21"	3.5"	250 lbs	54 lbs	\$953.00

Ultegra Accessories

Product #	Description	Weight	List Price
34232	USB-TO-AC POWER ADAPTER	1 lbs	\$23.00
29595C	1520 REMOTE DISPLAY 1.5" RoHS	2 lbs	\$210.00
20301	1500 SER 18" RMT DISPLAY STAND	6 lbs	\$96.00
29827C	USB CABLE - 6 FOOT	2 lbs	\$22.00
21100	ULTEGRA COUNTER INSERT FOR	22 lbs	\$257.00

Ultegra Health & Baggage Scales, Teleweigh & Slimline

Part #	Name / Description	List Price	Part #	Name / Description	List Price
35824C	ULTEGRA HEALTH SCALE 600LB CAP	\$628.00	27707	TELEWEIGH 500 LB HEALTH SCALE	\$431.00
32466	ULTEGRA BAGGAGE SCALE 31"x 31"	\$1,944.00	26889	SLIMLINE 600 LBS HEALTH SCALE	\$888.00

Parcel Dimensioner Shipping Scale

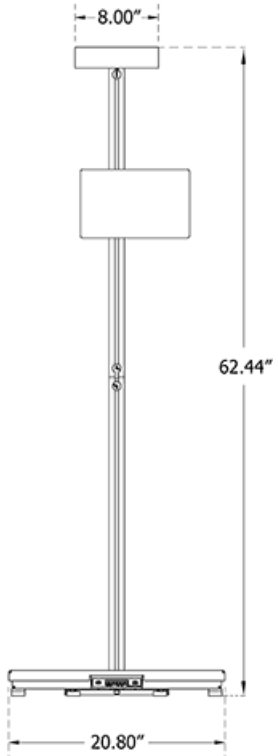
Complete Parcel Dimensioner Shipping Scale		
	<p>INCLUDES: Ultegra MAX scale 60' Pillar Dimensional Camera system Pillar mounted tablet PC Wireless keyboard. 1-year Remote Support for the dimensioning system. Support is for dimensioning system only. Support includes: Remote Support for dimensioning system Requires ethernet web connectivity. Cloud storage of: Collected box dimensions Collected box photos Collected box weights Support does not include support for Ultegra MAX scale. Calibration not included. On site assembly required.</p>	

Certifications		CC# Ultegra MAX = 10-0555; Dimensioner = 17-030	Dimensioner Specifications	
Scale Specifications			Maximum Box Size	48" x 36" x 40"
Capacity	250 lbs. (113 kg)		Minimum Box Size	6" x 6" x 3"
Division Size	0.05 lbs.		Pillar Height	60"
Output	USB		Linear Accuracy	+/- 0.5"
Power Requirements	USB Powered		Scan Time	~ 1 second
Display	0.5" high LCD		Power	120 VAC power required
Units	Pounds & Kilograms		Data Collected	Dimensions, Photo, Weight
Construction	Mild steel, black powder coated		Interface Options	Ethernet TCP/IP; wireless ethernet
			Surface Characteristics	Most surfaces including glossy and transparent shrink wrap

Parcel Dimensioner Pricing

Product #	Description	Platform Size	Divisions	Capacity	Weight	List Price
38275C	Parcel Dimensioner Shipping Scale	21" x 21"	0.05 lb	250 lb	75	\$8,653.00
38298	Dimensional Annual Support					\$622.00



Roller Conveyor Scale

	Specifications:	
	Capacity	250 lb. (113 kg)
	Division Size	0.2 lb. (0.1 kg)
	Table Size	36" x 55" x 32"
	Output	USB – Universal Serial Bus (includes 32' cable); RJ45 (for remote display connection)
	Power	USB cable (8')
	Display	1.5" tall LCD, 5 digits
	Units	Pounds and Kilograms
	Construction	Table: Mild Steel Rollers: Galvanized Steel
	Finish	Azure blue powder coated
	Accessories	Remote Display, Remote Display Pilar, RJ45 Splitter

Notes:

- Factory calibrated. Scales used in commercial applications must be placed in service by a certified technician.
- Commercially approved dimensional sizes available from 24" x 36" through 36" x 55" – contact the Solutions Group for a quote
- Other remote displays available – contact the Product Manager

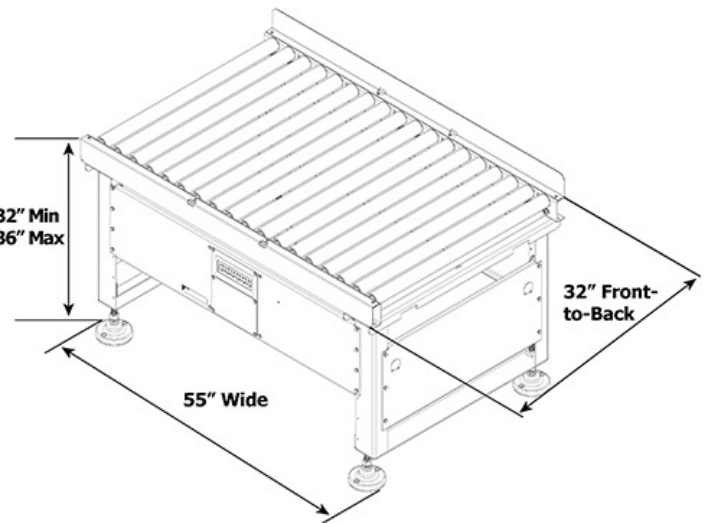

Roller Conveyor Scale

Product #	Description	Platform Size	Divisions	Capacity	Weight	List Price
37278	Roller Conveyor Scale, 250 lbs.	36" x 55" x 32"	0.2 lb	250 lb	500	\$7,507.00

Roller Conveyor Accessories

Product #	Description	Weight	List Price
34232	USB-TO-AC POWER ADAPTER	1	\$24.00
29595C	1520 REMOTE DISPLAY 1.5" RoHS	2	\$215.00
31162	RJ45 SPLITTER	1	\$36.49